

LED PANEL G3 LED FLAT PANEL FIXTURE | FLEXWATT + FLEXCOLOR + FLEXCONTROL



2x2, 2x4 & 1x4 flexibility

THE LED PANEL G3 IS OUR LATEST GENERATION OF EDGE-LIT LED FLAT PANEL FIXTURES, WHICH INTEGRATES REMPHOS' FLEXCOLOR, FLEXWATT & FLEXCONTROL TECHNOLOGIES.

selectable wattage & color temperature

flexCOLOR

- 3500°K NEUTRAL WHITE
- 4000°K NEUTRAL WHITE
- 5000°K COOL WHITE

flexWATT

2x2	16W	20W	24W	28W
1x4	16W	20W	24W	28W
2x4	20W	24W	28W	40W

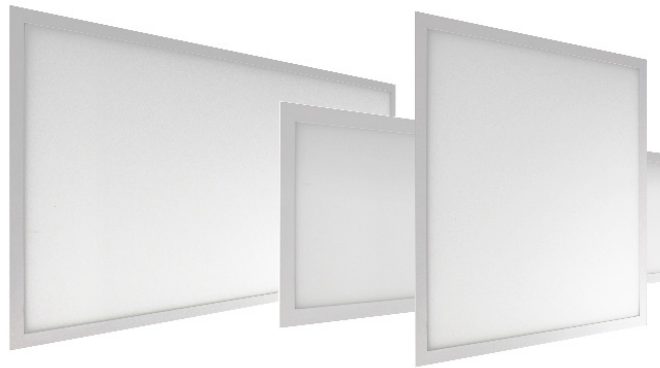

flexCONTROL

hidden integrated high/low motion sensor

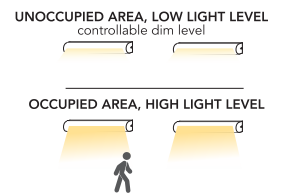

12 FIXTURES IN 1 WITH FLEXWATT™ & FLEXCOLOR™ TECHNOLOGY

- Eliminate ordering and stocking multiple wattages and color temperatures. Product offers 12 SKUs in 1 unit which can easily be configured to 4 different wattage packages and 3 different CCTs.
- Product ships at a default color temp (K) and wattage setting (install as is, or tailor the settings to fit your needs at your facility or on the job site)
- Save on labor costs by having us factory pre-set the wattage and color temperature to fit your project needs.

NEW PMMA LENS – HIGH EFFICIENCY 120-140LPW

- High transmission and high definition (HD) lens.
- Beautiful uniform illumination.
- PMMA material will not yellow over time like other market products.
- LPW varies based on wattage and color selected.

FLICKER-FREE LED DRIVER

FLEXCONTROL™ TECHNOLOGY

- Order control ready or basic control (integrated high/low and daylight sensor) or LG advanced control.
- Vandal Resistant Sensors are completely adjustable and hidden behind the fixture lens.
- Adjustable via remote for sensitivity, duration of time at high light level before dimming to low, duration of time at low light level before dimming to off (factory default is to disable), daylight hold-off, and the dimmed light level.

MANY MOUNTING OPTIONS

- Ships standard with clips for recessed and pendant install.
- Optional low-profile surface mount kit available.

EVERY COMBINATION IS DLC PREMIUM LISTED

10 YEAR WARRANTY, L70 >100,000HRS

OPTIONAL EMERGENCY BATTERY BACKUP

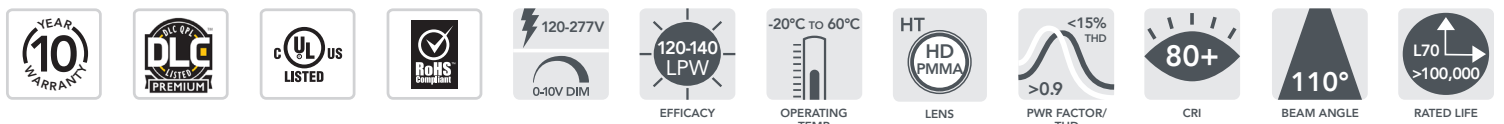

04.18.18 Information is subject to change without notice.

RemPhos by Light Efficient Design • 877.997.3674 • www.remphos.com
30 Log Bridge Road • Building 200 • Middleton, MA 01949 • USA

RemPhos by Light Efficient Design
lighting on target

LED PANEL G3 LED FLAT PANEL FIXTURE | FLEXWATT + FLEXCOLOR + FLEXCONTROL



HOW DOES IT WORK?

Our exclusive LED driver is designed to operate at 90%+ efficiency at each wattage setting. Standard drivers would have much lower efficiency as low as 60% and would result in poor performance and reduced efficacy.

WHAT ARE THE WATTAGE CHOICES?

The 2x2, 1x4 & 2x4 fixtures have different wattage/lumen offerings. Please reference this table and the ordering guide on the last page of the cut sheet.

FLEXWATT TURN DIAL POSITION				
SIZE	0	1	2	3
2X2	16W (20L)	20W (25L)	24W (31L)	28W (36L)
1X4	16W (20L)	20W (25L)	24W (31L)	28W (36L)
2X4	20W (25L)	24W (31L)	28W (36L)	40W (53L)

HOW EASY IS IT TO SET?

Simply open the driver cover, adjust the 4-position turn dial with a small, flat-head screw driver, and replace the cover. Quick and easy. Can be "locked-out" to prevent field-adjustability if desired.

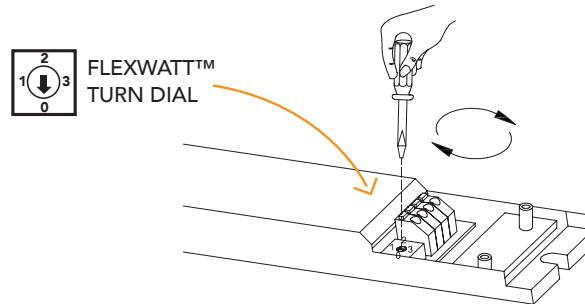

HOW DOES IT WORK?

We select the highest efficacy, multiple color LED diodes from quality suppliers, and mount them on the same circuit board. A proprietary LED binning process ensures color consistency between fixtures. The FlexColor technology controller ensures the correct color is selected, every time.

WHAT ARE THE COLOR CHOICES?

3500k, 4000k and 5000k. Please reference this table and the ordering guide on the last page of the cut sheet.

FLEXCOLOR SLIDE SWITCH POSITION		
TOP	MIDDLE	BOTTOM
3500K	4000K	5000K

HOW EASY IS IT TO SET?

Adjust the 3-position slide switch with your finger. Quick and easy. Can be "locked-out" to prevent field-adjustability if desired.

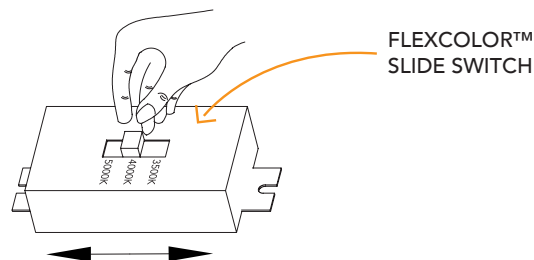

LED PANEL G3 LED FLAT PANEL FIXTURE | FLEXWATT + FLEXCOLOR + FLEXCONTROL

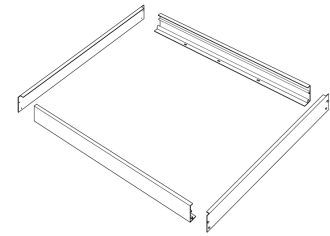
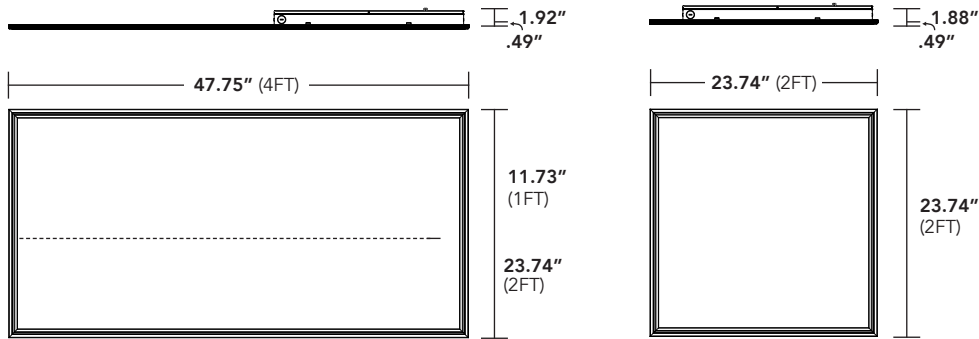

SURFACE MOUNT KIT ACCESSORY (2X2 SHOWN)
HEIGHT/DEPTH OF KIT 2.5"

CONTROL OPTIONS

CONTROL READY

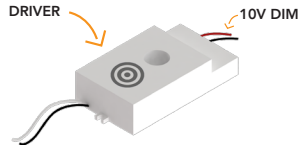

All LEDCR/SR come standard as factory enabled to add controls at the factory, in the field or at a later date. Driver comes with 10V dimming and 12V DC power wiring.

BASIC CONTROL



Integrated high frequency, high/low motion and daylight sensor. Can be mounted behind glass or plastic lens. Default settings: SENSITIVITY: 75%, TIME DIM: 5MIN, TIME OFF = DISABLED, PHOTOCELL: DISABLED, DIM LEVEL: 20%. Purchase optional remote control to adjust settings.

ORDERING CODES

SENSOR = OCC / REMOTE CONTROL = HC REMOTE

LG SENSOR CONNECT



LG's intelligent wireless lighting control system. ZigBee technology. Allows for occupancy sensing, daylight harvesting, grouping, scheduling, high-end trim and more. Adjust settings via Android app. Contact us for more details.

ORDERING CODE = LG or LGS

EASY INSTALL WITH INTEGRATED GRID CLIPS
SIMPLY BEND UP AND OUT. THEN, WHEN LOWERED INTO THE CEILING, THEY CATCH ON T-GRID BAR, FOR ADDED SUPPORT.

- FLEXWATT DRIVER
- SLIDE SWITCH FOR FLEX COLOR (3 CCT OPTIONAL)
- MOTION SENSOR (OPTIONAL)
- BACK COVER WITH ESD PROTECTION
- POSITION FOR EMG ATTACHMENT
- CLIPS FOR T-BAR INSTALLATION
- EVA PROTECTION PLATE
- 100% PMMA MATERIAL LIGHT GUIDE
- LED EFFICACY > 200LM/W L70 > 100,000HRS
- 100% PMMA NON-YELLOWING DIFFUSER
- 12.5MM THICK STRONG ALUMINUM FRAME

04.18.18 Information is subject to change without notice.

RemPhos by Light Efficient Design • 877.997.3674 • www.remphos.com
30 Log Bridge Road • Building 200 • Middleton, MA 01949 • USA

RemPhos by Light Efficient Design
lighting on target

LED PANEL G3 LED FLAT PANEL FIXTURE | FLEXWATT + FLEXCOLOR + FLEXCONTROL



PART NUMBER BUILDER

MFR	FAMILY	PRODUCT	GEN	SIZE	WATTAGE	COLOR	FUNCTION	OPTIONS	BAA
RPT	P	LED PANEL	G3				FWFC		
				2X2 → 20L,25L,31L,36L 1X4 → 20L,25L,31L,36L 2X4 → 25L,31L,36L,53L		835=3500K/85CRI 840=4000K/85CRI 850=5000K/85CRI	FWFC= FlexWatt + FlexColor	OCC=high/low motion sensor EMG=120min emergency battery backup LG=LG dongle LG5=LG dongle + sensor	BLANK=NON-BAA BAA=BAA Section 1605 Compliant

ORDERING EXAMPLE

RPT-P-LED PANEL-G3-2X2-20L-840-FWFC

Default lumen package (wattage and CCT) are shown below in bold. There are two ways to achieve a non-default lumen package and/or CCT:

1. You can easily adjust in field via our FlexWatt and FlexColor internal switches. 2. Have us adjust the FlexWatt and FlexColor at the factory for an additional charge.

SURFACE MOUNT ACCESSORIES

RPT-LED PANEL-SMK-2X2
RPT-LED PANEL-SMK-1X4
RPT-LED PANEL-SMK-2X4

ORDERING GUIDE

CASE QTY	ENERGY STAR	DLC	REMPHOS PART NUMBER	L.E.D. STOCK CODE	LUMEN OUTPUT (LM)	WATTAGE (W)	LPW	VOLTAGE RANGE (VAC)	WARRANTY (YRS)
2X2		▲	RPT-P-LED PANEL-G3-2X2-20L-835-FWFC		2000	16	125	120-277	10
		▲	RPT-P-LED PANEL-G3-2X2-20L-840-FWFC	RP-PNL-2X2-20L-40-01077	2032	16	127	120-277	10
		▲	RPT-P-LED PANEL-G3-2X2-20L-840-FWFC-OCC	RP-PNL-2X2-20L-40-01080	2032	16	127	120-277	10
		▲	RPT-P-LED PANEL-G3-2X2-20L-850-FWFC		2032	16	127	120-277	10
		▲	RPT-P-LED PANEL-G3-2X2-25L-835-FWFC		2500	20	125	120-277	10
		▲	RPT-P-LED PANEL-G3-2X2-25L-840-FWFC		2540	20	127	120-277	10
		▲	RPT-P-LED PANEL-G3-2X2-25L-850-FWFC		2540	20	127	120-277	10
		▲	RPT-P-LED PANEL-G3-2X2-31L-835-FWFC		3072	24	128	120-277	10
		▲	RPT-P-LED PANEL-G3-2X2-31L-840-FWFC		3120	24	130	120-277	10
		▲	RPT-P-LED PANEL-G3-2X2-31L-850-FWFC		3120	24	130	120-277	10
		▲	RPT-P-LED PANEL-G3-2X2-36L-835-FWFC		3584	28	128	120-277	10
		▲	RPT-P-LED PANEL-G3-2X2-36L-840-FWFC		3640	28	130	120-277	10
		▲	RPT-P-LED PANEL-G3-2X2-36L-850-FWFC		3640	28	130	120-277	10
	1X4		▲	RPT-P-LED PANEL-G3-1X4-20L-835-FWFC		1968	16	123	120-277
		▲	RPT-P-LED PANEL-G3-1X4-20L-840-FWFC		1984	16	123	120-277	10
		▲	RPT-P-LED PANEL-G3-1X4-20L-850-FWFC		1984	16	124	120-277	10
		▲	RPT-P-LED PANEL-G3-1X4-25L-835-FWFC		2460	20	123	120-277	10
		▲	RPT-P-LED PANEL-G3-1X4-25L-840-FWFC	RP-PNL-1X4-25L-40-01078	2480	20	124	120-277	10
		▲	RPT-P-LED PANEL-G3-1X4-25L-840-FWFC-OCC	RP-PNL-1X4-25L-40-01081	2480	20	124	120-277	10
		▲	RPT-P-LED PANEL-G3-1X4-25L-850-FWFC		2480	20	124	120-277	10
		▲	RPT-P-LED PANEL-G3-1X4-31L-835-FWFC		3000	24	125	120-277	10
		▲	RPT-P-LED PANEL-G3-1X4-31L-840-FWFC		3048	24	127	120-277	10
		▲	RPT-P-LED PANEL-G3-1X4-31L-850-FWFC		3048	24	127	120-277	10
		▲	RPT-P-LED PANEL-G3-1X4-36L-835-FWFC		3500	28	125	120-277	10
		▲	RPT-P-LED PANEL-G3-1X4-36L-840-FWFC		3556	28	127	120-277	10
		▲	RPT-P-LED PANEL-G3-1X4-36L-850-FWFC		3556	28	127	120-277	10
2X4			▲	RPT-P-LED PANEL-G3-2X4-25L-835-FWFC		2540	20	127	120-277
		▲	RPT-P-LED PANEL-G3-2X4-25L-840-FWFC		2600	20	130	120-277	10
		▲	RPT-P-LED PANEL-G3-2X4-25L-850-FWFC		2600	20	130	120-277	10
		▲	RPT-P-LED PANEL-G3-2X4-31L-835-FWFC		3048	24	127	120-277	10
		▲	RPT-P-LED PANEL-G3-2X4-31L-840-FWFC		3120	24	130	120-277	10
		▲	RPT-P-LED PANEL-G3-2X4-31L-850-FWFC		3120	24	130	120-277	10
		▲	RPT-P-LED PANEL-G3-2X4-36L-835-FWFC		3696	28	132	120-277	10
		▲	RPT-P-LED PANEL-G3-2X4-36L-840-FWFC	RP-PNL-2X4-36L-40-01079	3612	28	129	120-277	10
		▲	RPT-P-LED PANEL-G3-2X4-36L-840-FWFC-OCC	RP-PNL-2X4-36L-40-01082	3612	28	129	120-277	10
		▲	RPT-P-LED PANEL-G3-2X4-36L-850-FWFC		3696	28	132	120-277	10
		▲	RPT-P-LED PANEL-G3-2X4-53L-835-FWFC		5160	40	129	120-277	10
		▲	RPT-P-LED PANEL-G3-2X4-53L-840-FWFC		5280	40	132	120-277	10
		▲	RPT-P-LED PANEL-G3-2X4-53L-850-FWFC		5280	40	132	120-277	10

● DLC STANDARD ▲ DLC PREMIUM

04.18.18 Information is subject to change without notice.

RemPhos by Light Efficient Design • 877.997.3674 • www.remphos.com
30 Log Bridge Road • Building 200 • Middleton, MA 01949 • USA

RemPhos by Light Efficient Design
lighting on target